

SP1044 Series 30pF 30kV Unidirectional Discrete TVS



OBSOLETE DATE: 6/10/2020 PCN/ECN# ESU270-51
REPLACED BY: SP1020-01WTG



Description

Avalanche breakdown diodes fabricated in a proprietary silicon avalanche technology protect each I/O pin to provide a high level of protection for electronic equipment that may experience destructive electrostatic discharges (ESD). These robust diodes can safely absorb repetitive ESD strikes at ±30kV (contact discharge, IEC 61000-4-2) without performance degradation. Additionally, each diode can safely dissipate 3A of 8/20µs surge current (IEC 61000-4-5 2nd edition) with very low clamping voltages

Pinout

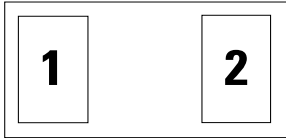

Note: Drawing not to scale

Features

- ESD, IEC 61000-4-2, ±30kV contact, ±30kV air
- EFT, IEC 61000-4-4, 40A (5/50ns)
- Lightning, IEC 61000-4-5, 2nd edition, 3A (t_p=8/20µs)
- Low capacitance of 30pF (@ V_R=0V)
- Low leakage current of 0.1µA at 5V
- Industries smallest ESD footprint available (01005)
- Halogen free, Lead free and RoHS compliant

Functional Block Diagram

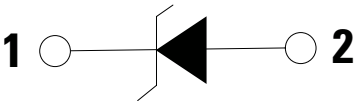

Applications

- Mobile Phones
- Smart Phones
- Camcorders
- Portable Medical
- Digital Cameras
- Wearable Technology
- Portable Navigation Components
- Tablets
- Point of Sale Terminals

Life Support Note:
Not Intended for Use in Life Support or Life Saving Applications
The products shown herein are not designed for use in life sustaining or life saving applications unless otherwise expressly indicated.

Absolute Maximum Ratings

Symbol	Parameter	Value	Units
I_{PP}	Peak Current ($t_p=8/20\mu s$)	3.0 ¹	A
T_{OP}	Operating Temperature	-40 to 125	°C
T_{STOR}	Storage Temperature	-55 to 150	°C

1. CAUTION: Stresses above those listed in "Absolute Maximum Ratings" may cause permanent damage to the component. This is a stress only rating and operation of the component at these or any other conditions above those indicated in the operational sections of this specification is not implied.

Thermal Information

Parameter	Rating	Units
Storage Temperature Range	-55 to 150	°C
Maximum Junction Temperature	150	°C
Maximum Lead Temperature (Soldering 20-40s)	260	°C

Electrical Characteristics ($T_{OP}=25^{\circ}C$)

Parameter	Symbol	Test Conditions	Min	Typ	Max	Units
Reverse Standoff Voltage	V_{RWM}	-	-	-	6.0	V
Leakage Current	I_{LEAK}	$V_R=5V$ with 1 pin at GND	-	0.1	0.5	μA
Clamp Voltage ¹	V_C	$I_{pp}=1A, t_p=8/20\mu s$, Fwd	-	8.3	-	V
		$I_{pp}=2A, t_p=8/20\mu s$, Fwd	-	9.3	-	V
Dynamic Resistance ²	R_{DYN}	TLP, $t_p=100ns$, I/O to GND	-	0.18	-	Ω
ESD Withstand Voltage ¹	V_{ESD}	IEC 61000-4-2 (Contact Discharge)	± 30	-	-	kV
		IEC 61000-4-2 (Air Discharge)	± 30	-	-	kV
Diode Capacitance ¹	C_D	Reverse Bias=0V	-	30	35	pF

Notes:

- Parameter is guaranteed by design and/or component characterization.
- Transmission Line Pulse (TLP) with 100ns width, 2ns rise time, and average window $t_1=70ns$ to $t_2=90ns$

8/20 μs Pulse Waveform

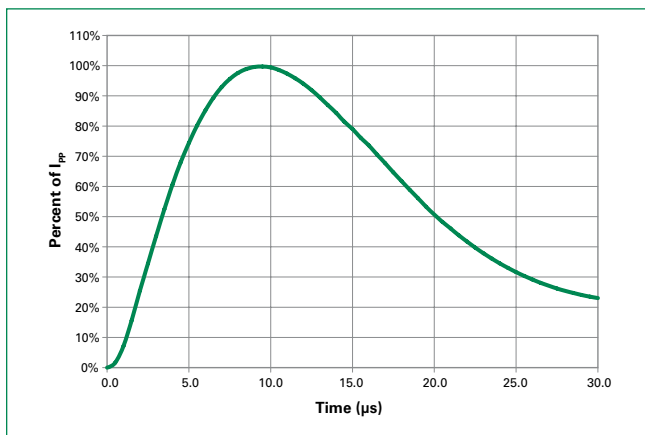

Capacitance vs. Reverse Bias

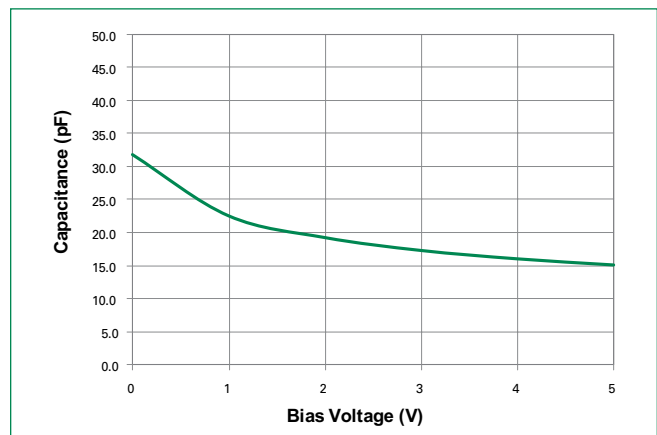

Postive Transmission Line Pulsing(TLP) Plot

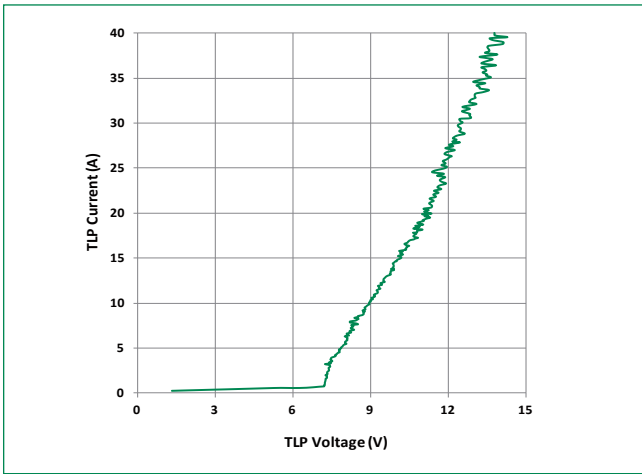

Negative Transmission Line Pulsing(TLP) Plot

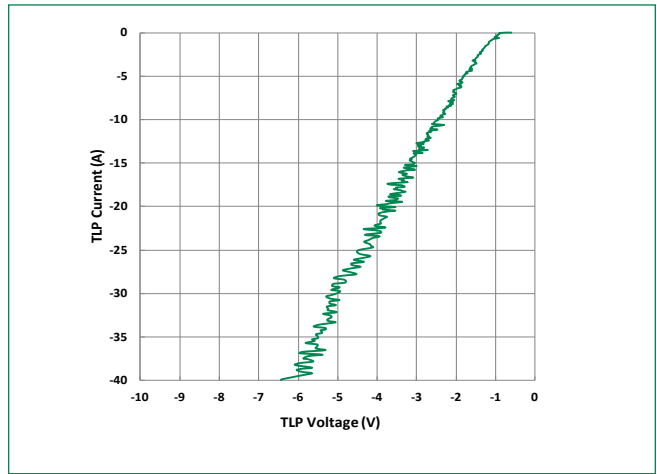

Clamping Voltage vs I_{pp}

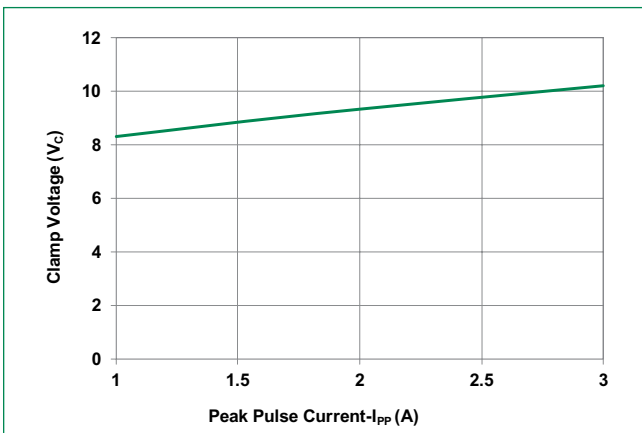

Soldering Parameters

Reflow Condition		Pb – Free assembly
Pre Heat	- Temperature Min ($T_{s(min)}$)	150°C
	- Temperature Max ($T_{s(max)}$)	200°C
	- Time (min to max) (t_s)	60 – 180 secs
Average ramp up rate (Liquidus) Temp (T_L) to peak		3°C/second max
$T_{S(max)}$ to T_L - Ramp-up Rate		3°C/second max
Reflow	- Temperature (T_L) (Liquidus)	217°C
	- Temperature (t_L)	60 – 150 seconds
Peak Temperature (T_p)		260 ^{+0/-5} °C
Time within 5°C of actual peak Temperature (t_p)		20 – 40 seconds
Ramp-down Rate		6°C/second max
Time 25°C to peak Temperature (T_p)		8 minutes Max.
Do not exceed		260°C

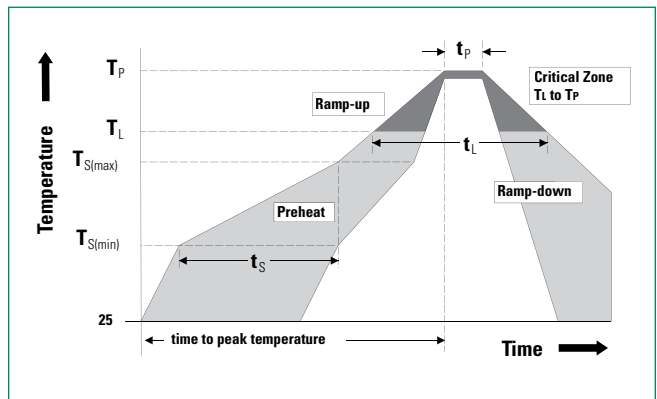

Part Marking System

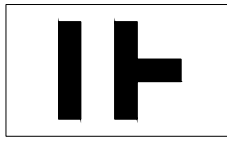

Part Numbering System

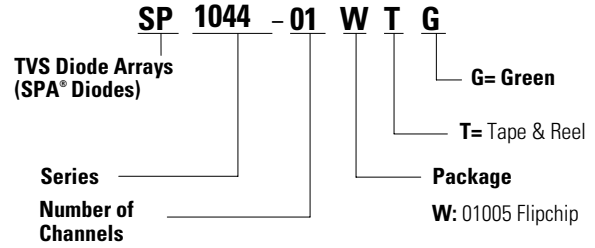

Ordering Information

Part Number	Package	Min. Order Qty.
SP1044-01WTG	01005 Flipchip	15000

Package Dimensions — 01005 Flipchip

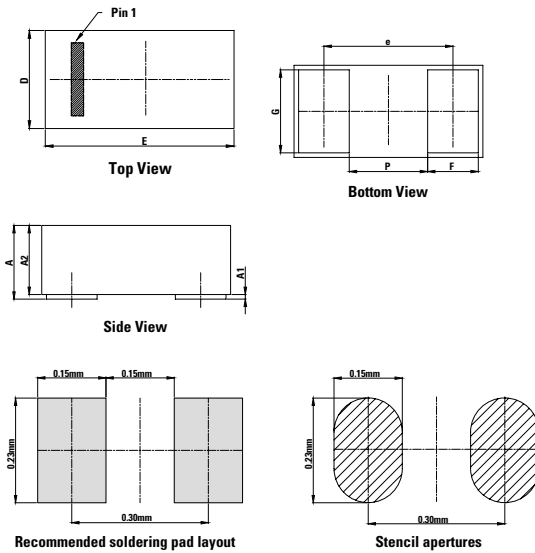

Symbol	01005 Flipchip					
	Millimeters			Inches		
	Min	Typ	Max	Min	Typ	Max
A	0.168	0.181	0.194	0.007	0.007	0.008
A1	0.008	0.011	0.014	0.000	0.000	0.001
A2	0.160	0.170	0.180	0.006	0.007	0.007
e	0.280 BSC			0.011 BSC		
D	0.200	0.230	0.260	0.008	0.009	0.010
E	0.400	0.430	0.460	0.016	0.017	0.018
F	0.110	0.130	0.150	0.004	0.005	0.006
G	0.180	0.200	0.220	0.007	0.008	0.009
P	0.130	0.150	0.170	0.005	0.006	0.007

Embossed Carrier Tape & Reel Specification — 01005 Flipchip

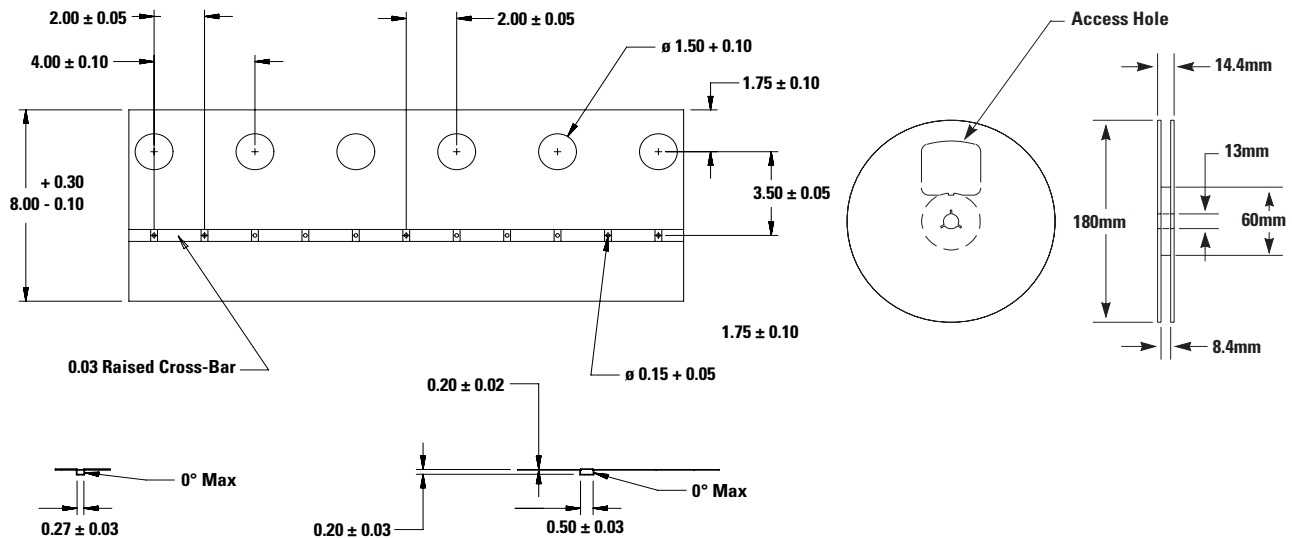

Disclaimer Notice - Information furnished is believed to be accurate and reliable. However, users should independently evaluate the suitability of and test each product selected for their own applications. Littelfuse products are not designed for, and may not be used in, all applications. Read complete Disclaimer Notice at: www.littelfuse.com/disclaimer-electronics