

SP1009 Series 30pF 30kV Bidirectional Discrete TVS

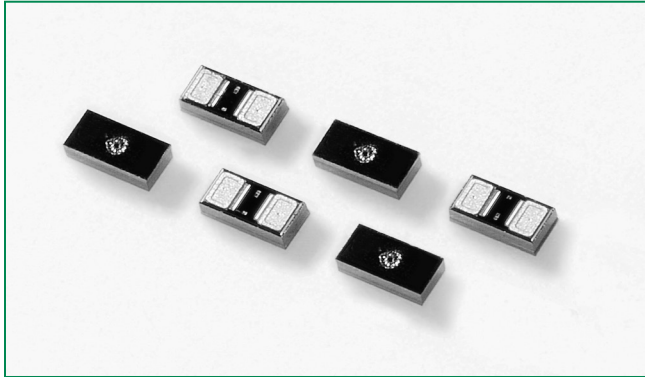

OBSOLETE DATE: 12/31/2020 PCN/ECN# ESU270-48
REPLACED BY: SP1026-01UTG



Pinout

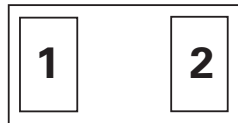

Functional Block Diagram



Description

The SP1009 includes back-to-back Zener diodes fabricated in a proprietary silicon avalanche technology to provide protection for electronic equipment that may experience destructive electrostatic discharges (ESD). These robust diodes can safely absorb repetitive ESD strikes above the maximum level specified in the IEC61000-4-2 international standard (Level 4, ±8 kV contact discharge and ±15 kV air discharge) without performance degradation. The back-to-back configuration provides symmetrical ESD protection for data lines when AC signals are present.

Features

- ESD, IEC61000-4-2, ±30kV contact, ±30kV air
- EFT, IEC61000-4-4, 40A (5/50ns)
- IEC 61000-4-5, 2nd Edition: 8/20 Surge, 10A Surge Immunity
- Low capacitance of 30pF (@ $V_R=0V$)
- Low leakage current of 0.1µA at 5V
- Space efficient 0201 footprint
- Halogen free, lead-free and RoHS compliant.

Applications

- Mobile phones
- Smart phones
- Camcorders
- PDA
- Digital cameras
- MP3/PMP
- Portable navigation devices
- Portable medical
- Point of sale terminals

Application Example

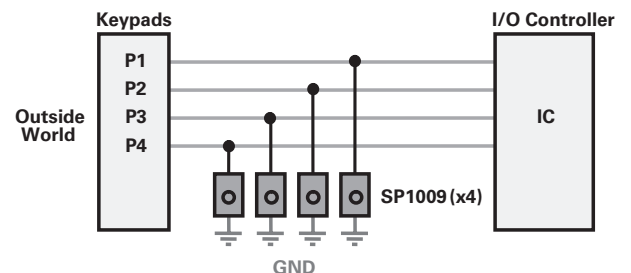

Life Support Note:

Not Intended for Use in Life Support or Life Saving Applications

The products shown herein are not designed for use in life sustaining or life saving applications unless otherwise expressly indicated.

Absolute Maximum Ratings

Symbol	Parameter	Value	Units
I_{PP}	Peak Current ($t_p=8/20\mu s$)	10.0	A
T_{OP}	Operating Temperature	-40 to 85	°C
T_{STOR}	Storage Temperature	-65 to 150	°C

CAUTION: Stresses above those listed in "Absolute Maximum Ratings" may cause permanent damage to the component. This is a stress only rating and operation of the component at these or any other conditions above those indicated in the operational sections of this specification is not implied.

Thermal Information

Parameter	Rating	Units
Storage Temperature Range	-65 to 150	°C
Maximum Junction Temperature	150	°C
Maximum Lead Temperature (Soldering 20-40s)	260	°C

Electrical Characteristics ($T_{OP}=25^\circ C$)

Parameter	Symbol	Test Conditions	Min	Typ	Max	Units
Reverse Standoff Voltage	V_{RWM}				6.0	V
Breakdown Voltage	V_{BR}	$I_R=1\text{mA}$	7.0	8.5	9.5	V
Leakage Current	I_{LEAK}	$V_R=5\text{V}$ with 1 pin at GND		0.1	0.5	μA
Clamp Voltage ¹	V_C	$I_{PP}=1\text{A}$, $t_p=8/20\mu s$, Fwd		9.3		V
		$I_{PP}=2\text{A}$, $t_p=8/20\mu s$, Fwd		10.0		V
		$I_{PP}=10\text{A}$, $t_p=8/20\mu s$, Fwd		15.6		V
Dynamic Resistance	R_{DYN}	$(V_{C2} - V_{C1}) / (I_{PP2} - I_{PP1})$		0.7		Ω
ESD Withstand Voltage ¹	V_{ESD}	IEC61000-4-2 (Contact Discharge)	± 30			kV
		IEC61000-4-2 (Air Discharge)	± 30			kV
Diode Capacitance ¹	C_D	Reverse Bias=0V		30		pF
		Reverse Bias=2.5V		23		pF

Note:

¹Parameter is guaranteed by design and/or component characterization.

Product Characteristics

Lead Plating	Sn
Lead Material	Copper
Lead Coplanarity	6 μm (max)
Substrate material	Silicon
Body Material	Silicon

Notes :

- All dimensions are in millimeters
- Dimensions include solder plating.
- Dimensions are exclusive of mold flash & metal burr.
- Blo is facing up for mold and facing down for trim/form, i.e. reverse trim/form.
- Package surface matte finish VDI 11-13.

Capacitance vs. Reverse Bias

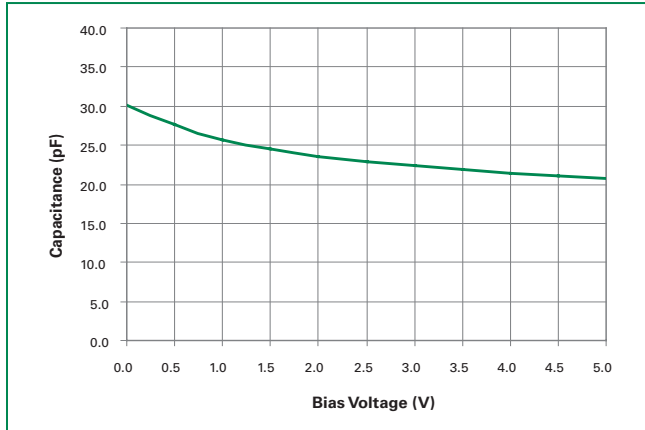

8/20µS Pulse Waveform

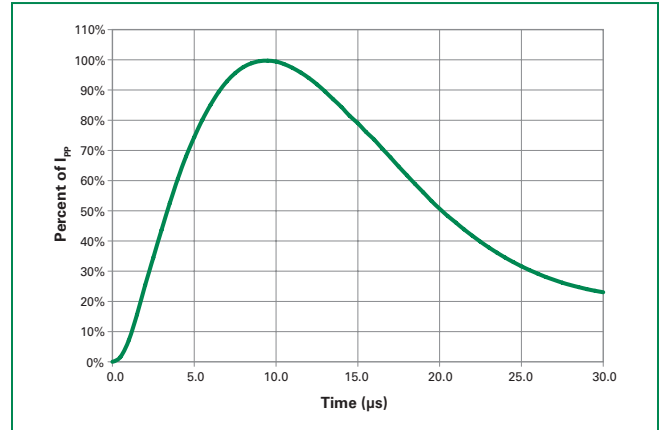

Clamping Voltage vs. I_{pp}

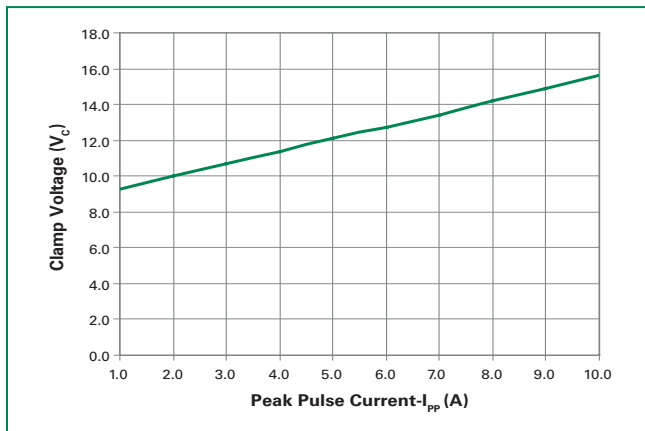

Insertion Loss (S21) I/O to GND

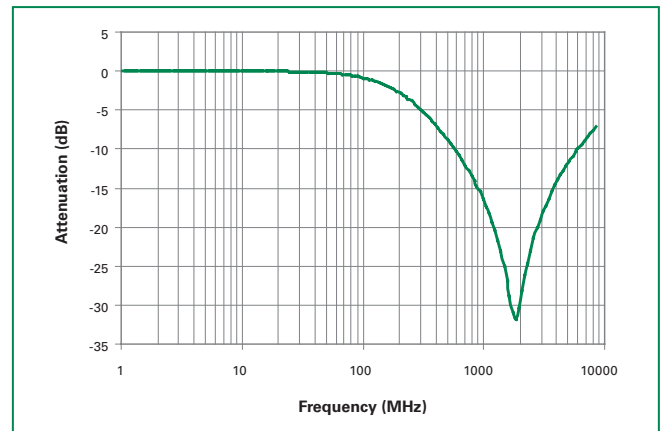

Soldering Parameters

Reflow Condition	Pb – Free assembly	
Pre Heat	- Temperature Min (T _{s(min)})	150°C
	- Temperature Max (T _{s(max)})	200°C
	- Time (min to max) (t _s)	60 – 180 secs
Average ramp up rate (Liquidus) Temp (T _L) to peak	3°C/second max	
T _{S(max)} to T _L - Ramp-up Rate	3°C/second max	
Reflow	- Temperature (T _L) (Liquidus)	217°C
	- Temperature (t _L)	60 – 150 seconds
Peak Temperature (T _p)	260 ^{+0/-5} °C	
Time within 5°C of actual peak Temperature (t _p)	20 – 40 seconds	
Ramp-down Rate	6°C/second max	
Time 25°C to peak Temperature (T _p)	8 minutes Max.	
Do not exceed	260°C	

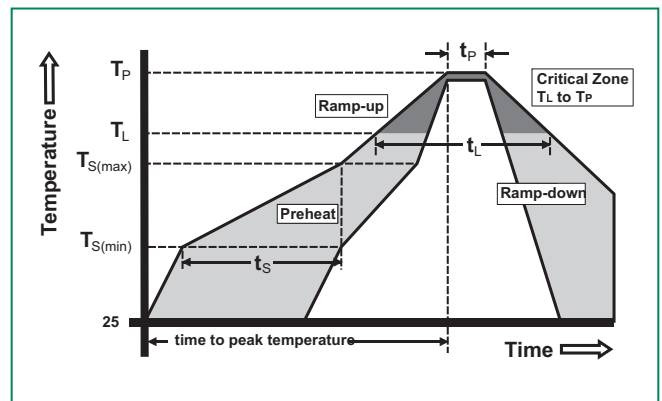

Package Dimensions – 0201 Flipchip

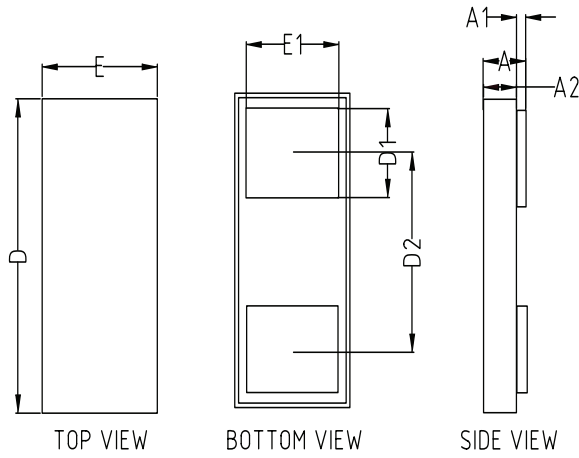

Symbol	0201 Flipchip			
	Millimeters		Inches	
	Min	Max	Min	Max
D	0.605	0.655	0.023819	0.025787
E	0.305	0.355	0.012008	0.013976
D1	0.145	0.155	0.005709	0.006102
E1	0.245	0.255	0.009646	0.010039
D2	0.4 BSC		0.0157 BSC	
A	0.273	0.329	0.010748	0.012953
A2	0.265	0.315	0.010433	0.012402
A1	0.008	0.014	0.000315	0.000551

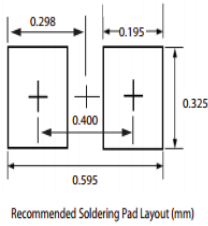

Part Numbering System

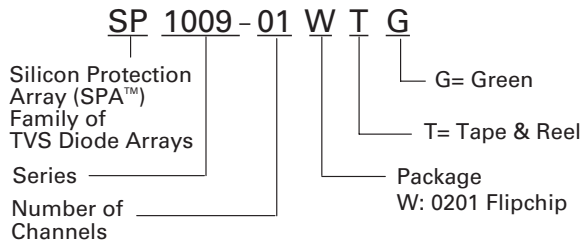

Part Marking System

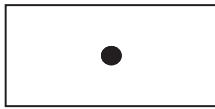

Ordering Information

Part Number	Package	Marking	Min. Order Qty.
SP1009-01WTG	0201 Flipchip	•	10000

Embossed Carrier Tape & Reel Specification – 0201 Flipchip

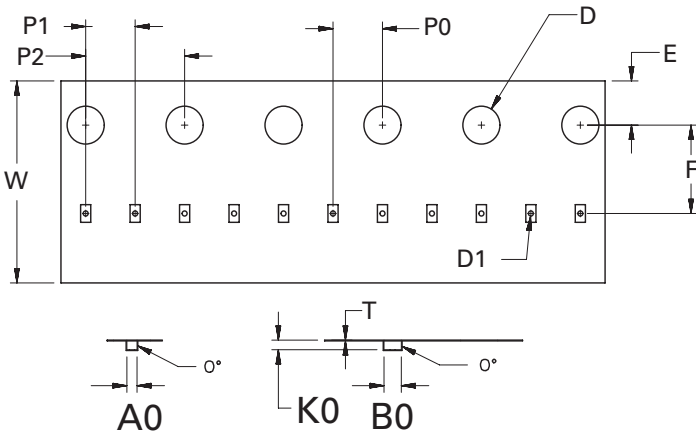

Symbol	Millimeters
A0	0.41+/-0.03
B0	0.70+/-0.03
D	ø 1.50 + 0.10
D1	ø 0.20 +/- 0.05
E	1.75+/-0.10
F	3.50+/-0.05
K0	0.38+/-0.03
P0	2.00+/-0.05
P1	2.00+/-0.05
P2	4.00+/-0.10
W	8.00+0.30/-0.10
T	0.23+/-0.02