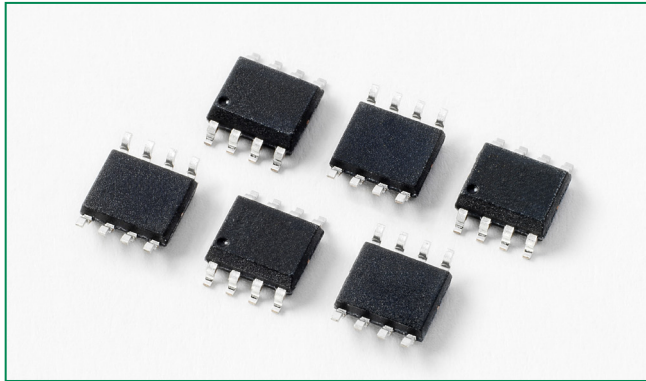
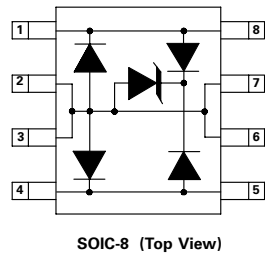


# SP03A-3.3 Series 3.3V 150A Diode Array

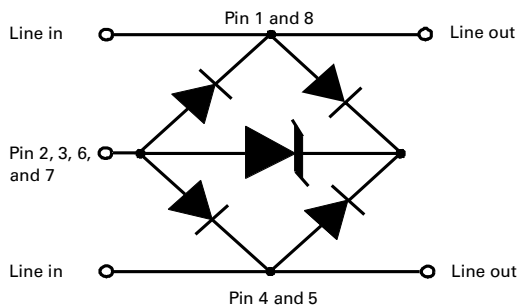
**OBSOLETE** DATE: 2016 PCN/ECN# N/A  
REPLACED BY: LC03-3.3BTG TVS Diode Array



## Pinout



## Functional Block Diagram



Life Support Note:

**Not Intended for Use in Life Support or Life Saving Applications**

The products shown herein are not designed for use in life sustaining or life saving applications unless otherwise expressly indicated.

## Description

This SP03A provides overvoltage protection for applications such as 10/100/1000 BaseT Ethernet, and T3/E3 interfaces. This new protector combines the TVS diode element with a diode rectifier bridge to provide both longitudinal and differential protection in one package. This design results in a capacitive loading characteristic that is log-linear with respect to the signal voltage across the device. This reduces intermodulation (IM) distortion caused by a typical solid-state protection solution. The application schematic provides the connection information and the SP03A is rated for GR-1089, intra-building transient immunity requirements for telecommunication installations.

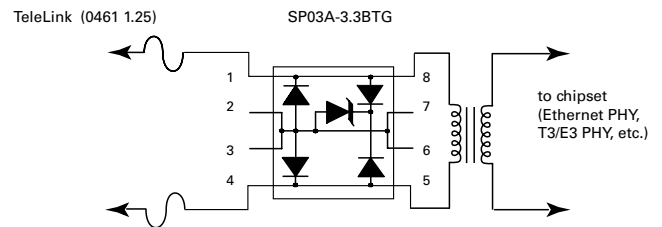
## Features

- Lightning Protection, IEC 61000-4-5 2nd edition, 150A ( $t_P=8/20\mu s$ )
- EFT, IEC 61000-4-4, 40A ( $t_P=5/50ns$ )
- Low insertion loss, log-linear capacitance
- Low clamping voltage
- SOIC-8 surface mount package (JEDEC MS-012)
- Combined longitudinal and metallic protection
- Clamping speed of nanoseconds
- UL V-0 Flammability epoxy molding
- RoHS compliant and lead-free

## Applications

- T1/E1 Line cards
- T3/E3 and DS3 Interfaces
- STS-1 Interfaces
- 10/100/1000 BaseT Ethernet

## Application Example



This schematic shows a high-speed data interface protection solution. The SP03A-3.3BTG is compatible with the intra-building surge requirements of Telcordia's GR-1089-CORE, and the Basic Level Recommendations of ITU K.20 and K.21. The TeleLink fuse provides overcurrent protection for the long term 50/60 Hz power fault events.

**OBSOLETE** DATE: 2016 PCN/ECN# N/A  
REPLACED BY: LC03-3.3BTG TVS Diode Array

**Absolute Maximum Ratings**

Parameter	Rating	Units
Peak Pulse Current (8/20µs)	150	A
Peak Pulse Power (8/20µs)	3300	W
IEC 61000-4-2, Direct Discharge, (Level 4)	30	kV
IEC 61000-4-2, Air Discharge, (Level 4)	30	kV
IEC 61000-4-5 (8/20µs)	150	A
Telcordia GR 1089 (Intra-Building) (2/10µs)	100	A
ITU K.20 (5/310µs)	40	A

CAUTION: Stresses above those listed in "Absolute Maximum Ratings" may cause permanent damage to the device. This is a stress only rating and operation of the device at these or any other conditions above those indicated in the operational sections of this specification is not implied.

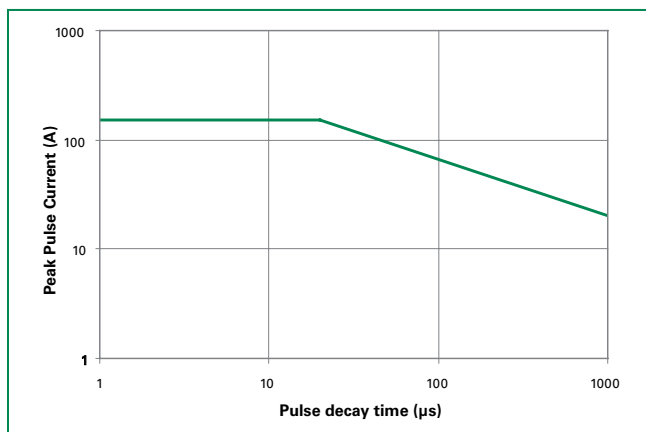
**Thermal Information**

Parameter	Rating	Units
SOIC Package	170	°C/W
Operating Temperature Range	-40 to 125	°C
Storage Temperature Range	-55 to 150	°C
Maximum Junction Temperature	150	°C
Maximum Lead Temperature (Soldering 20-40s) (SOIC - Lead Tips Only)	260	°C

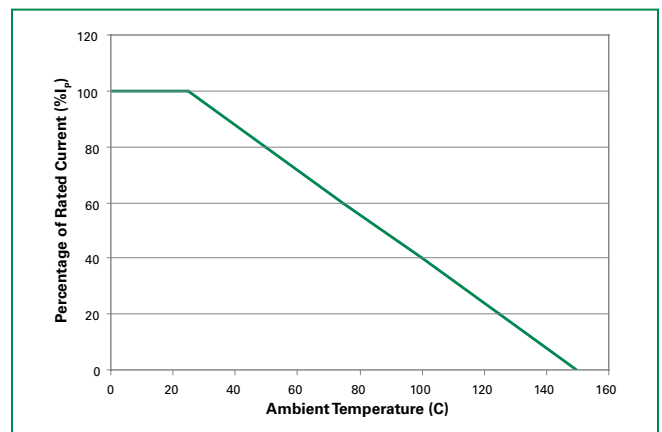
**Electrical Characteristics (T<sub>OP</sub> = 25°C)**

Parameter	Symbol	Test Conditions	Min	Typ	Max	Units
Reverse Stand-Off Voltage	V <sub>RWM</sub>	I <sub>T</sub> ≤ 1µA	-	-	3.3	V
Reverse Breakdown Voltage	V <sub>BR</sub>	I <sub>T</sub> = 2µA	3.3	-	-	V
Snap Back Voltage	V <sub>SB</sub>	I <sub>T</sub> = 50mA	3.3	-	-	V
Reverse Leakage Current	I <sub>R</sub>	V <sub>RWM</sub> = 3.3V, T = 25°C	-	-	1	µA
Clamping Voltage, Line-Ground	V <sub>C</sub>	I <sub>PP</sub> = 50A, t <sub>p</sub> = 8/20 µs	-	-	13	V
Clamping Voltage, Line-Ground	V <sub>C</sub>	I <sub>PP</sub> = 100A, t <sub>p</sub> = 8/20 µs	-	-	17	V
Dynamic Resistance, Line-Ground	R <sub>DYN</sub>	(V <sub>C2</sub> - V <sub>C1</sub> ) / (I <sub>PP2</sub> - I <sub>PP1</sub> )	-	0.15	-	Ω
Clamping Voltage, Line-Line	V <sub>C</sub>	I <sub>PP</sub> = 50A, t <sub>p</sub> = 8/20 µs	-	-	15	V
Clamping Voltage, Line-Line	V <sub>C</sub>	I <sub>PP</sub> = 100A, t <sub>p</sub> = 8/20 µs	-	-	20	V
Dynamic Resistance, Line-Line	R <sub>DYN</sub>	(V <sub>C2</sub> - V <sub>C1</sub> ) / (I <sub>PP2</sub> - I <sub>PP1</sub> )	-	0.25	-	Ω
Junction Capacitance	C <sub>J</sub>	Between I/O Pins and Ground V <sub>R</sub> = 0V, f = 1MHz	-	9	12	pF
		Between I/O Pins V <sub>R</sub> = 0V, f = 1MHz	-	4.5	6	pF

**Figure 1: Non-repetitive Peak Pulse Current vs. Pulse Time**

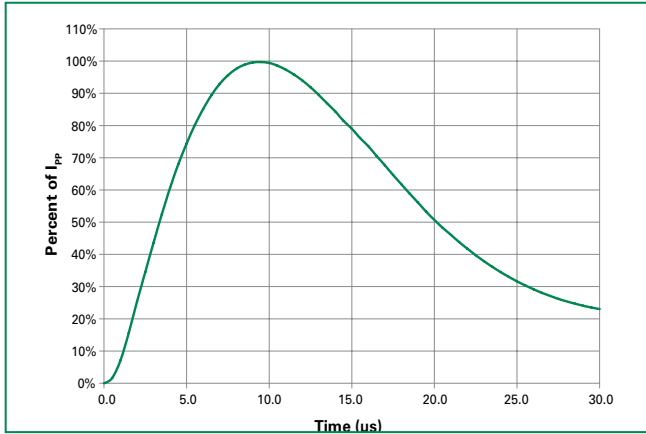


**Figure 2: Current Derating Curve**

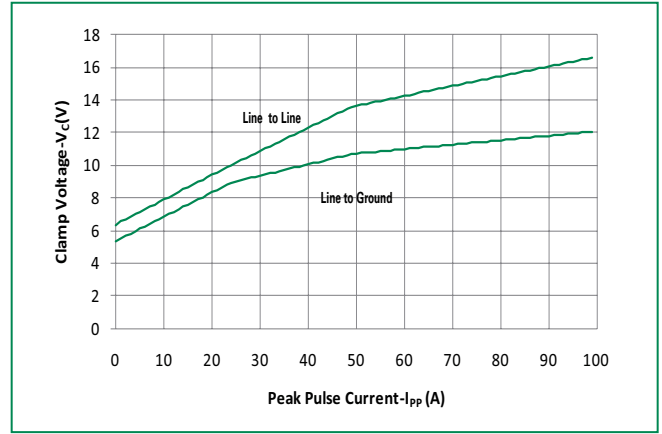


**OBSOLETE** DATE: 2016 PCN/ECN# N/A  
REPLACED BY: LC03-3.3BTG TVS Diode Array

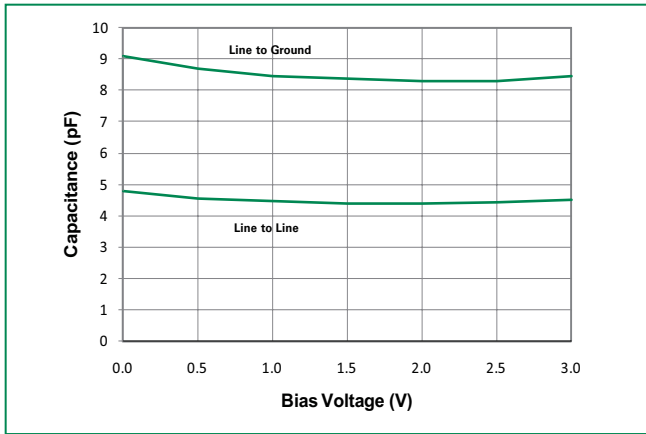
**Figure 3: 8/20µS Pulse Waveform**



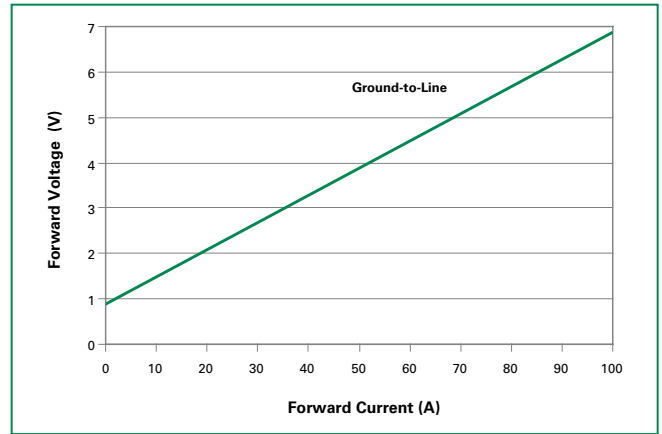
**Figure 4: Clamping Voltage vs. Peak Pulse Current**



**Figure 5: Capacitance vs. Reverse Voltage**

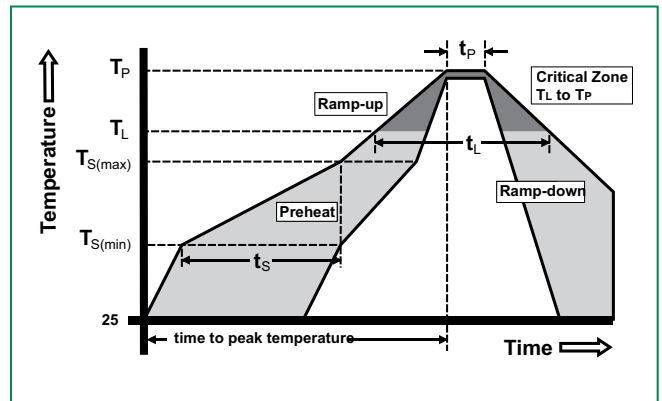


**Figure 6: Forward Voltage vs. Forward Current**



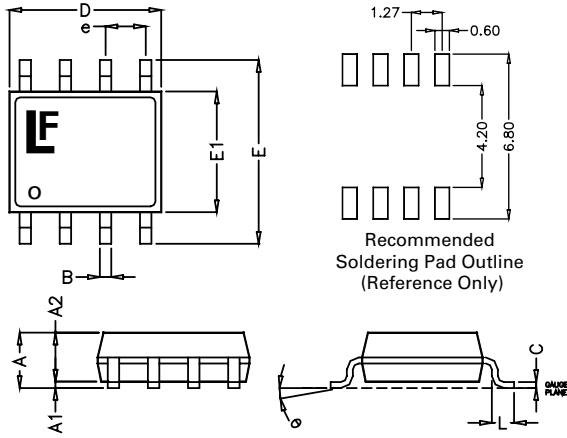
**Soldering Parameters**

Reflow Condition	Pb – Free assembly	
Pre Heat	- Temperature Min (T <sub>s(min)</sub> )	150°C
	- Temperature Max (T <sub>s(max)</sub> )	200°C
	- Time (min to max) (t <sub>s</sub> )	60 – 180 secs
Average ramp up rate (Liquidus) Temp (T <sub>L</sub> ) to peak	3°C/second max	
T <sub>S(max)</sub> to T <sub>L</sub> - Ramp-up Rate	3°C/second max	
Reflow	- Temperature (T <sub>L</sub> ) (Liquidus)	217°C
	- Temperature (t <sub>L</sub> )	60 – 150 seconds
Peak Temperature (T <sub>p</sub> )	260 <sup>+0/-5</sup> °C	
Time within 5°C of actual peak Temperature (t <sub>p</sub> )	20 – 40 seconds	
Ramp-down Rate	6°C/second max	
Time 25°C to peak Temperature (T <sub>p</sub> )	8 minutes Max.	
Do not exceed	260°C	



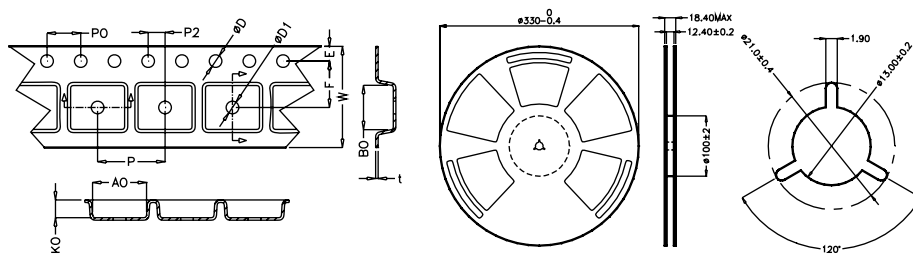
**OBSOLETE** DATE: 2016 PCN/ECN# N/A  
REPLACED BY: LC03-3.3BTG TVS Diode Array

**Package Dimensions – Mechanical Drawings and Recommended Solder Pad Outline**



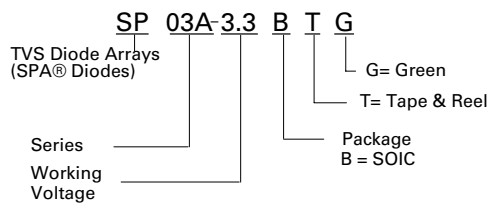
Package	SOIC			
Pins	8			
JEDEC	MS-012			
	Millimetres		Inches	
	Min	Max	Min	Max
<b>A</b>	1.35	1.75	0.053	0.069
<b>A1</b>	0.10	0.25	0.004	0.010
<b>A2</b>	1.25	1.65	0.050	0.065
<b>B</b>	0.31	0.51	0.012	0.020
<b>c</b>	0.17	0.25	0.007	0.010
<b>D</b>	4.80	5.00	0.189	0.197
<b>E</b>	5.80	6.20	0.228	0.244
<b>E1</b>	3.80	4.00	0.150	0.157
<b>e</b>	1.27 BSC		0.050 BSC	
<b>L</b>	0.40	1.27	0.016	0.050

**Embossed Carrier Tape & Reel Specification – SOIC Package**

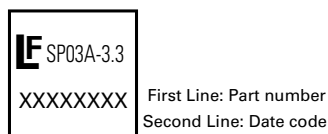


	Millimetres		Inches	
	Min	Max	Min	Max
<b>E</b>	1.65	1.85	0.065	0.073
<b>F</b>	5.4	5.6	0.213	0.22
<b>P2</b>	1.95	2.05	0.077	0.081
<b>D</b>	1.5	1.6	0.059	0.063
<b>D1</b>	1.50 Min		0.059 Min	
<b>P0</b>	3.9	4.1	0.154	0.161
<b>10P0</b>	40.0 +/- 0.20		1.574 +/- 0.008	
<b>W</b>	11.9	12.1	0.468	0.476
<b>P</b>	7.9	8.1	0.311	0.319
<b>A0</b>	6.3	6.5	0.248	0.256
<b>B0</b>	5.1	5.3	0.2	0.209
<b>K0</b>	2	2.2	0.079	0.087
<b>t</b>	0.30 +/- 0.05		0.012 +/- 0.002	

**Part Numbering System**



**Part Marking System**



**Ordering Information**

Part Number	Package	Marking	Min. Order Qty.
SP03A-3.3BTG	SOIC Tape & Reel	SP03A-3.3	2500

**Product Characteristics**

<b>Lead Plating</b>	Matte Tin
<b>Lead Material</b>	Copper Alloy
<b>Lead Coplanarity</b>	0.004 inches (0.102mm)
<b>Substrate material</b>	Silicon
<b>Body Material</b>	Molded Epoxy
<b>Flammability</b>	UL 94 V-0

- Notes :
- All dimensions are in millimeters
  - Dimensions include solder plating.
  - Dimensions are exclusive of mold flash & metal burr.
  - Blo is facing up for mold and facing down for trim/form, i.e. reverse trim/form.
  - Package surface matte finish VDI 11-13.