

# CHIPSESD DEVICES

Littelfuse's ChipSESD family of Silicon ESD devices, available in EIA-0201 and EIA-0402 sized rectangular SMT passive component packages, can help protect electronic circuits against damage from electrostatic discharge (ESD) events.

The SESD0201P1BN-0400-090, 0201-sized ChipSESD device's miniature footprint (0.6mm x 0.3mm x 0.3mm) is approximately 70% smaller than prior-generation devices. This offers designers flexibility in space constrained applications.

The ChipSESD devices are high-capacitance, bi-directional devices that can be used for low-speed generic interfaces such as keypads, power buttons, speakers and microphone ports in a portable electronics. The bi-directional operation eliminates orientation constraints and the need for polarity inspections. The surface mount technology (SMT) passive component package allows the devices to be easily installed onto the printed circuit board using the standard PCB assembly process. Once soldered onto the boards, the ChipSESD's solder fillets at the end terminals can easily be visually inspected.

The ChipSESD devices offer 10kV contact and 16kV air discharge protection per the IEC61000-4-2, level 4 standard with a surge rating of 2A under 8x20Qs pulse.

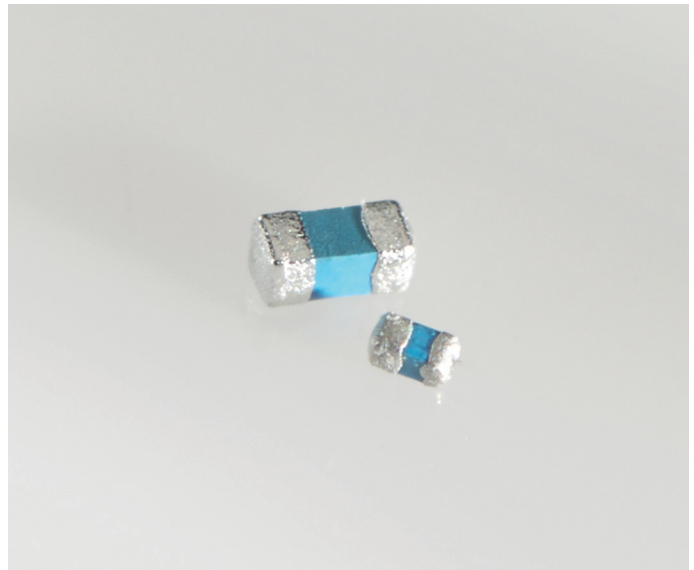

## BENEFITS

- Silicon ESD devices in an EIA-0201 and EIA-0402 sized rectangular SMT passive component package
- Bi-directional operation eliminates orientation constraints
- Standard PCB assembly and rework process
- ESD protection in space-constrained portable electronics and mobile handsets
- Helps protect electronic circuits against damage from ESD
- Assists equipment to pass IEC61000-4-2, level 4 testing

## FEATURES

- Input capacitance -4.0pF (typ) & 4.5pF (typ)
- Low leakage current - 1.0µA (max)
- Low working reverse voltage - 6.0V (max)
- Capable of withstanding numerous ESD strikes
- RoHS compliant
- Halogen free  
(refers to: Br≥900ppm, Cl≥900ppm, Br+Cl≥1500ppm)

## APPLICATIONS

- Mobile phones and portable electronics
- Digital cameras and camcorders
- Notebooks, set top boxes, motherboards
- USB 2.0 and computer I/O ports
- Applications requiring high ESD performance in a small package

## Table CE1 – Maximum Ratings

Part Number	IEC61000-4-2, level 4 (ESD Withstand)		Temperature	
	Contact (kV)	Air (kV)	Operating (°C)	Storage (°C)
SESD0201P1BN-0400-090	±10*	±16	-40 to +125	-40 to +125
SESD0402P1BN-0450-090	±10*	±16	-40 to +125	-40 to +125

## Table CE2 – Electrical Characteristics @ T=25°C

Part Number	Input Capacitance*		Leakage Current (max) I <sub>L</sub> @ V <sub>RWM</sub> = 6.0V (µA)	Breakdown Voltage (min) V <sub>br</sub> @ I <sub>T</sub> <sup>†</sup> = 1mA (V)	Working Reverse Voltage V <sub>RWM</sub> @ peak (V)	Clamping Voltage (typ) V <sub>CL</sub> @ I <sub>pp</sub> =2A, tp=(8/20µs) (V)*
	Typ (pF)	Max (pF)				
SESD0201P1BN-0400-090	4.0	5.0	1.0	9.0	6.0	+10.0
SESD0402P1BN-0450-090	4.5	5.5	1.0	9.0	6.0	+10.0

\* @ Vr=0V, f=1MHz

† V<sub>br</sub> is measured at test current I<sub>T</sub>

## Figure CE1 – ESD Clamping Voltage - 8kV Contact

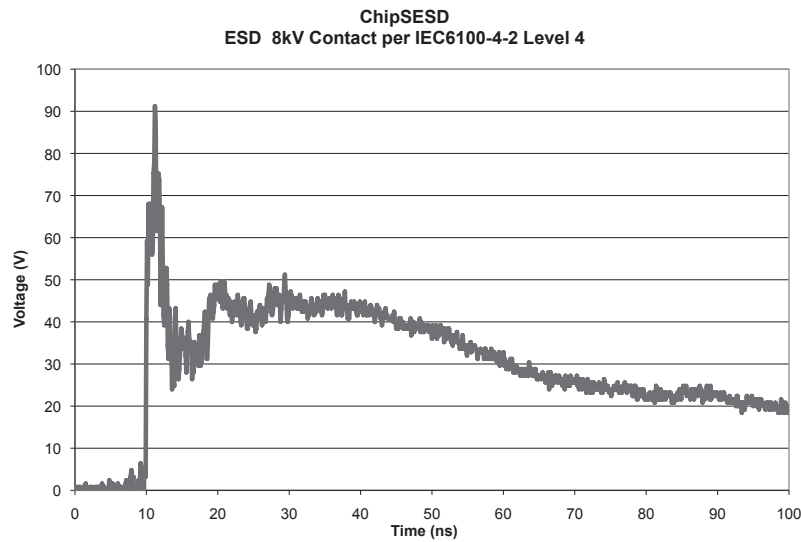

## Figure CE2 – ESD Clamping Voltage - 8x20µs, 2A Surge

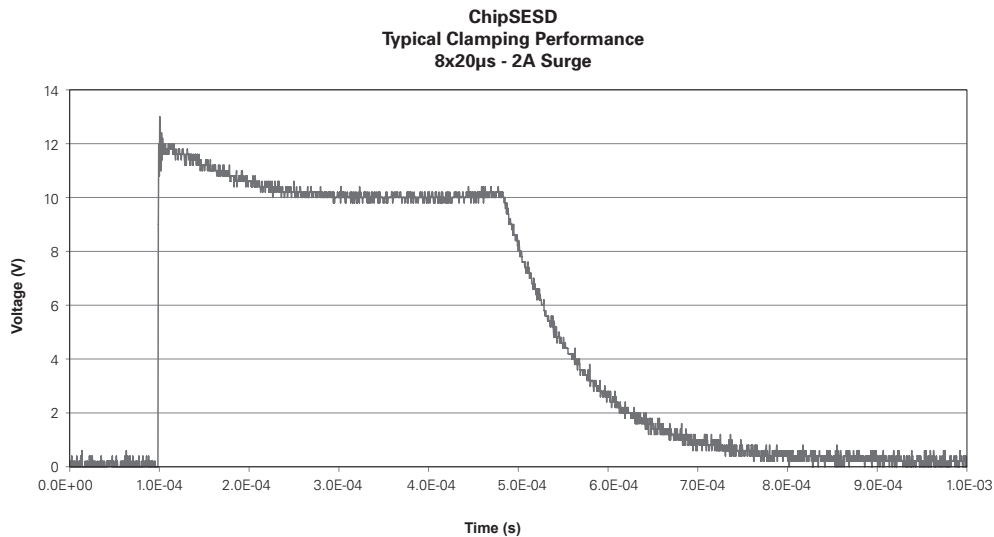

# ChipSESD Devices

## Table CE3 - Dimensions in Millimeters and (Mils)\*

Part Number	A	B	C	D	Figure
SESD0201P	0.60 ± 0.05	0.30 ± 0.05	0.30 ± 0.05	0.21 ± 0.07	CE3
	(23.62 ± 2.00)	(11.81 ± 2.00)	(11.81 ± 2.00)	(8.27 ± 2.80)	
SESD0402P	1.10 ± 0.10	0.50 ± 0.10	0.50 ± 0.10	0.25 ± 0.15	CE3
	(43.31 ± 0.40)	(19.69 ± 4.00)	(19.69 ± 4.00)	(9.84 ± 6.00)	

\* Round off approximation

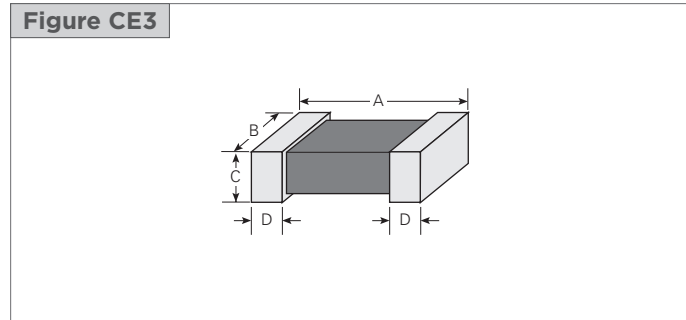

## Table CE4 - PCB Pad Layout in Millimeters and (Mils)\*

Part Number	L	S	W	Figure
SESD0201P	0.28 ± 0.01	0.19 ± 0.01	0.30 ± 0.01	CE4
	(11.00 ± 0.40)	(7.50 ± 0.40)	(11.80 ± 0.40)	
SESD0402P	0.61 ± 0.05	0.52 ± 0.05	0.50 ± 0.05	CE4
	(24.00 ± 2.00)	(21.00 ± 2.00)	(20.00 ± 2.00)	

\* Round off approximation

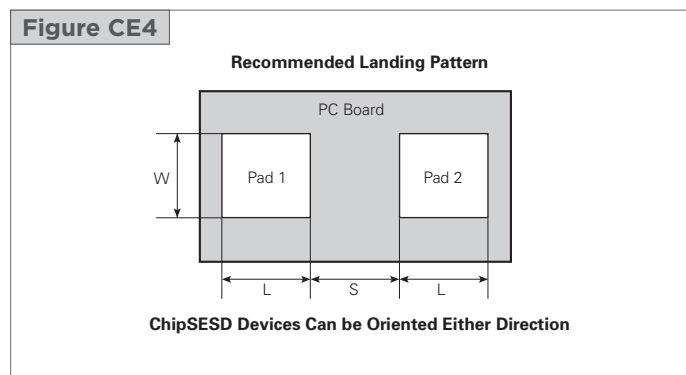

## Table CE5 – Tape Specifications

Tape Dimension EIA Mark	SESD0201P1BN-0400-090	SESD0402P1BN-0450-090
	Dimension (mm)	Dimension (mm)
A	$0.35 \pm 0.02$	$0.58 \pm 0.03$
B	$0.67 \pm 0.02$	$1.20 \pm 0.03$
D	$1.55 \pm 0.05$	$1.55 \pm 0.05$
E	$1.75 \pm 0.05$	$1.75 \pm 0.05$
F	$3.50 \pm 0.05$	$3.50 \pm 0.05$
W	$8.00 \pm 0.10$	$8.00 \pm 0.10$
P <sub>0</sub>	$4.00 \pm 0.10$	$4.00 \pm 0.10$
P <sub>1</sub>	$2.00 \pm 0.05$	$2.00 \pm 0.05$
P <sub>2</sub>	$2.00 \pm 0.05$	$2.00 \pm 0.05$
T	$0.42 \pm 0.03$	$0.60 \pm 0.03$

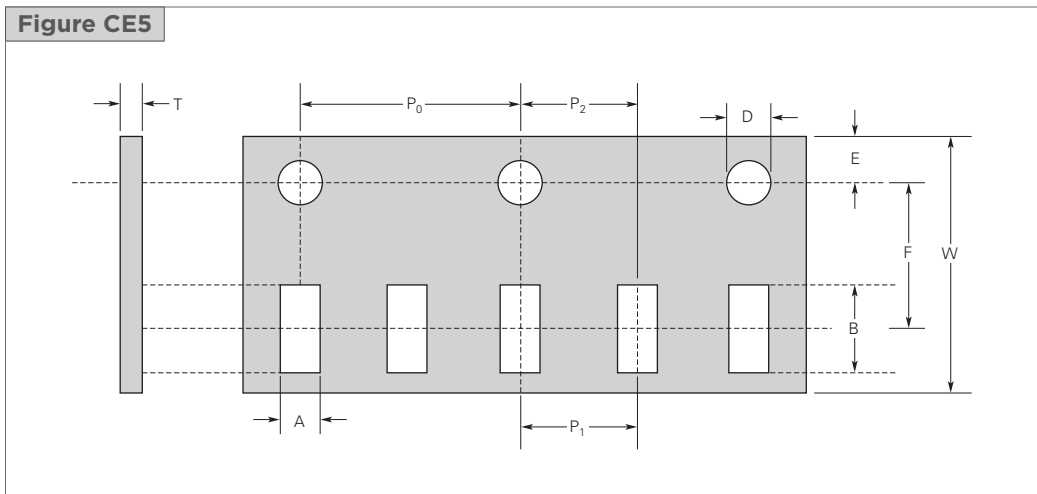

## Table CE6 – Reel Specifications

Reel Dimension EIA Mark	Dimension (mm)
A	$178.0 \pm 2.0$
B	$2.0 \pm 0.5$
C	$13.0 \pm 0.5$
D	$21.0 \pm 0.8$
E	$62.0 \pm 1.5$
F	$9.0 \pm 0.5$
G	$13.0 \pm 1.0$

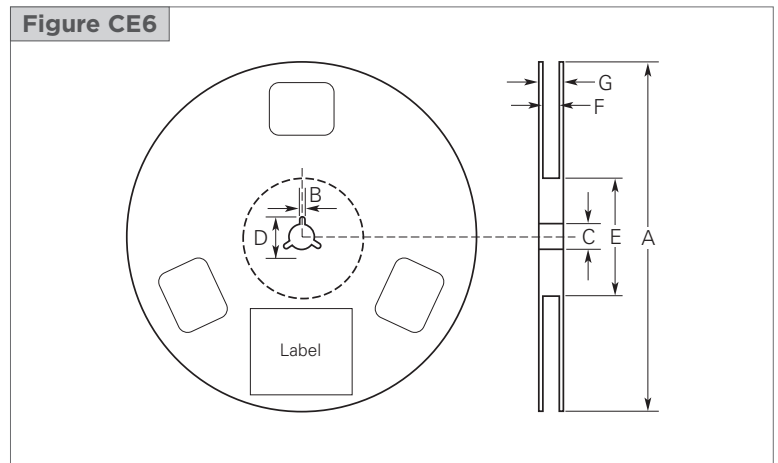

# ChipSESD Devices

## Definition of Terms

$I_L$	Reverse Leakage Current @ $V_{RWM}$
$V_{RWM}$	Working Peak Reverse Voltage
$V_{br}$	Breakdown Voltage @ $I_T$
$I_T$	Test Current
$V_{CL}$	Clamping Voltage

## Part Numbering System

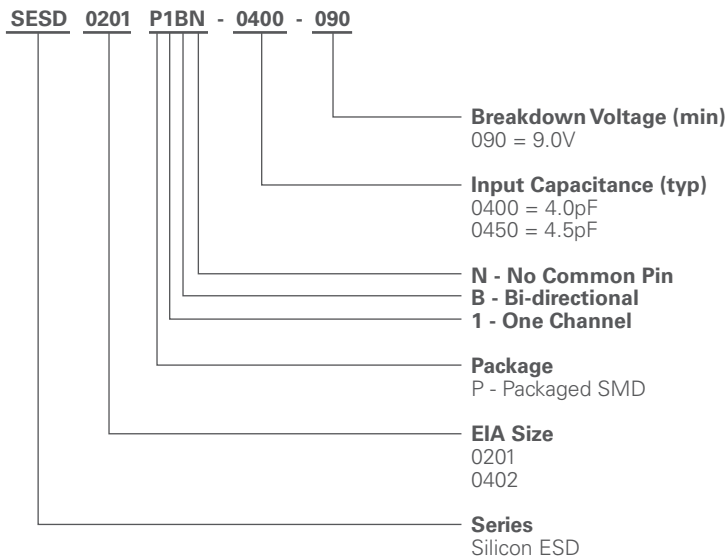

### Notice:

Littelfuse products are not designed for, and shall not be used for, any purpose (including, without limitation, automotive, military, aerospace, medical, life-saving, life-sustaining or nuclear facility applications, devices intended for surgical implant into the body, or any other application in which the failure or lack of desired operation of the product may result in personal injury, death, or property damage) other than those expressly set forth in applicable Littelfuse product documentation. Warranties granted by Littelfuse shall be deemed void for products used for any purpose not expressly set forth in applicable Littelfuse documentation. Littelfuse shall not be liable for any claims or damages arising out of products used in applications not expressly intended by Littelfuse as set forth in applicable Littelfuse documentation. The sale and use of Littelfuse products is subject to Littelfuse Terms and Conditions of Sale, unless otherwise agreed by Littelfuse.

