

LSIC2SD065E16CCA 650 V, 16 A SiC Schottky Barrier Diode



Description

This series of silicon carbide (SiC) Schottky diodes has negligible reverse recovery current, high surge capability, and a maximum operating junction temperature of 175 °C. This diode series is ideal for applications where improvements in efficiency, reliability, and thermal management are desired.

Features

- AEC-Q101 qualified
- Positive temperature coefficient for safe operation and ease of paralleling
- 175 °C. maximum operating junction temperature
- Excellent surge capability
- Extremely fast, temperature-independent switching behavior
- Dramatically reduced switching losses compared to Si bipolar diodes

Applications

- Boost diodes in PFC or DC/DC stages
- Switch-mode power supplies
- Uninterruptible power supplies
- Solar inverters
- Industrial motor drives
- EV charging stations

Environmental

- Littelfuse "RoHS" logo = RoHS conform
- Littelfuse "HF" logo = Halogen Free
- Littelfuse "Pb-free" logo = = Pb-free lead plating

Circuit Diagram TO-247-3L

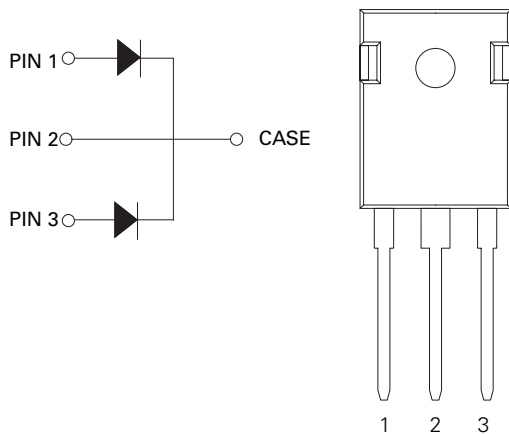

Maximum Ratings

Characteristics	Symbol	Conditions	Value	Unit
Repetitive Peak Reverse Voltage	V_{RRM}	-	650	V
DC Blocking Voltage	V_R	$T_J = 25\text{ °C}$	650	V
Continuous Forward Current (Per Leg/Component)	I_F	$T_C = 25\text{ °C}$	23 / 46	A
		$T_C = 135\text{ °C}$	10.7 / 21.4	
		$T_C = 150\text{ °C}$	8 / 16	
Non-Repetitive Forward Surge Current (Per Leg)	I_{FSM}	$T_C = 25\text{ °C}$, $t_p = 10\text{ ms}$, Half sine pulse	40	A
Power Dissipation (Per Leg/Component)	P_{Tot}	$T_C = 25\text{ °C}$	88 / 176	W
		$T_C = 110\text{ °C}$	38 / 76	
Operating Junction Temperature	T_J	-	-55 to 175	°C
Storage Temperature	T_{STG}	-	-55 to 150	°C
Soldering Temperature	T_{sold}	-	260	°C

Electrical Characteristics ($T_J = 25\text{ }^\circ\text{C}$ unless otherwise specified)

Characteristics	Symbol	Conditions	Value			Unit
			Min.	Typ.	Max.	
Forward Voltage	V_F	$I_F = 8\text{ A}, T_J = 25\text{ }^\circ\text{C}$	-	1.5	1.8	V
		$I_F = 8\text{ A}, T_J = 175\text{ }^\circ\text{C}$	-	1.85	-	
Reverse Current	I_R	$V_R = 650\text{ V}, T_J = 25\text{ }^\circ\text{C}$	-	<1	50	μA
		$V_R = 650\text{ V}, T_J = 175\text{ }^\circ\text{C}$	-	15	-	
Total Capacitance	C	$V_R = 1\text{ V}, f = 1\text{ MHz}$	-	415	-	pF
		$V_R = 200\text{ V}, f = 1\text{ MHz}$	-	56	-	
		$V_R = 400\text{ V}, f = 1\text{ MHz}$	-	41	-	
Total Capacitive Charge	Q_C	$V_R = 800\text{ V}, Q_C = \int_0^{V_R} C(V)dV$	-	29	-	nC

Thermal Characteristics

Characteristics	Symbol	Value	Unit
Thermal Resistance (Per Leg/Component)	$R_{\theta JC}$	1.7 / 0.85	$^\circ\text{C/W}$

Figure 1: Typical Forward Characteristics

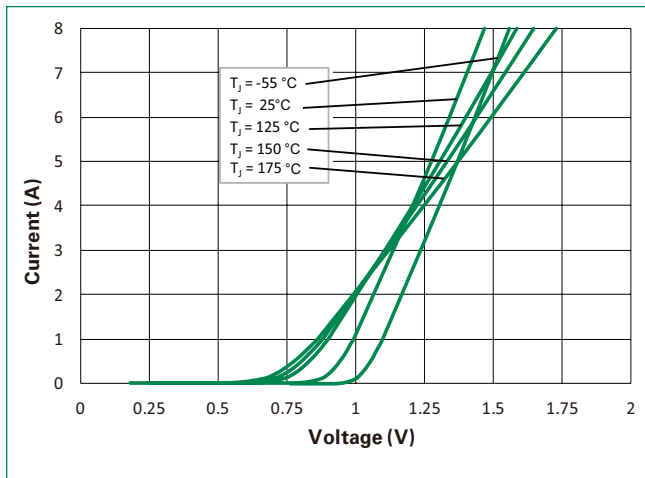

Figure 2: Typical Reverse Characteristics

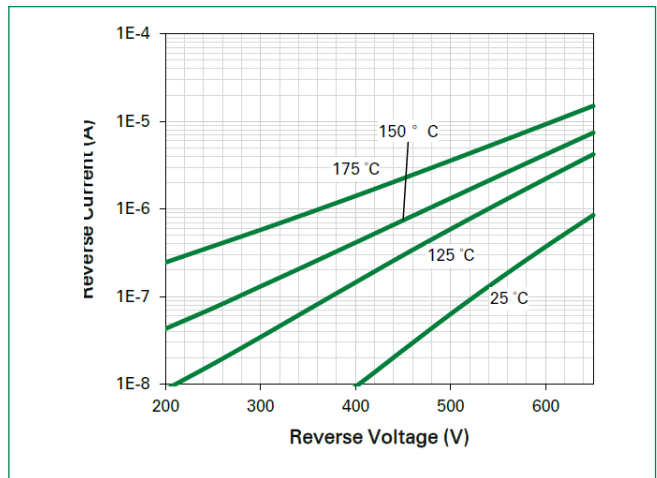

Figure 3: Power Derating

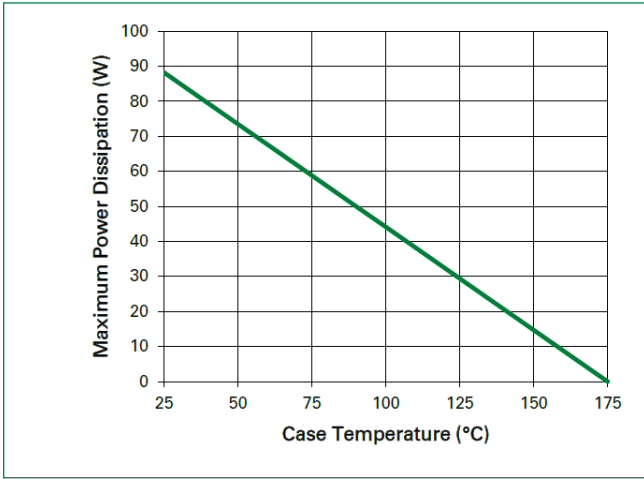

Figure 4: Current Derating

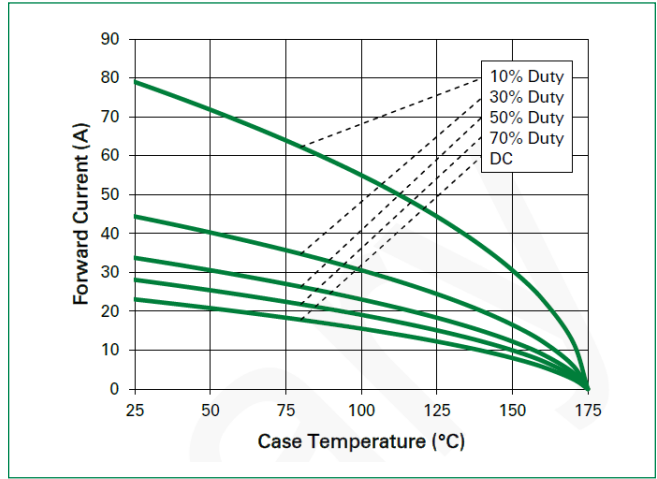

Figure 5: Capacitance vs. Reverse Voltage

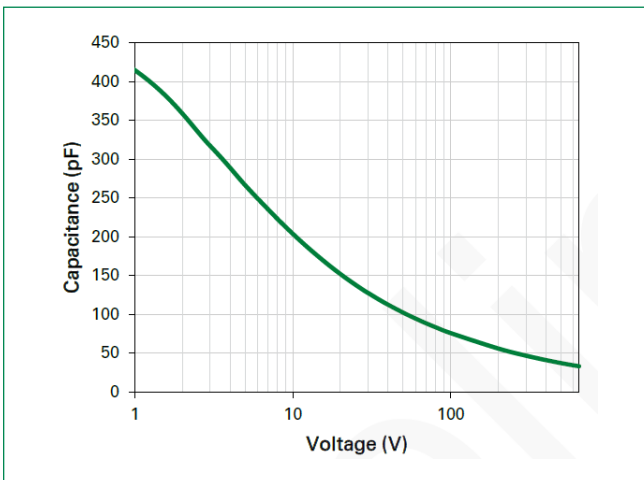

Figure 6: Capacitive Charge vs. Reverse Voltage

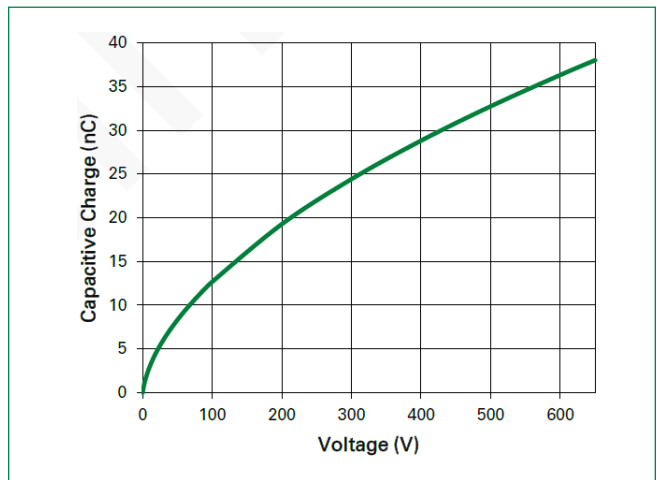

Figure 7: Stored Energy vs. Reverse Voltage

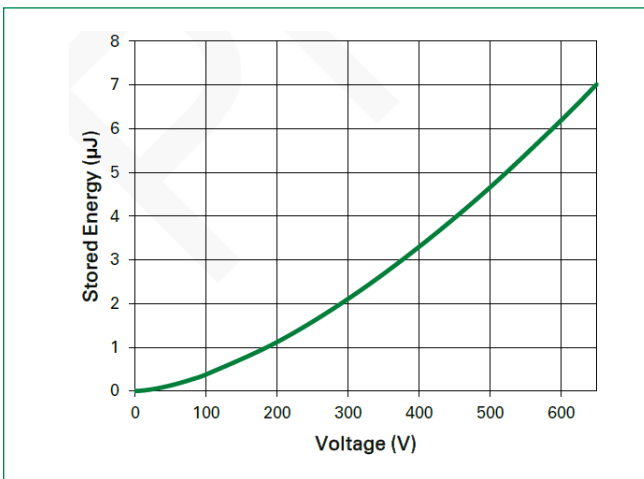
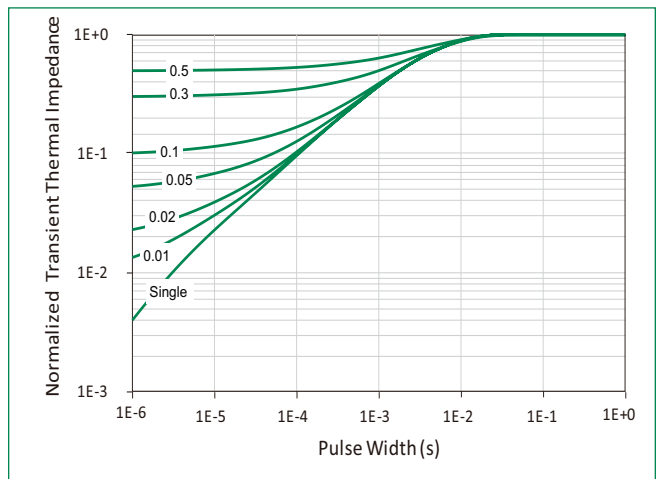
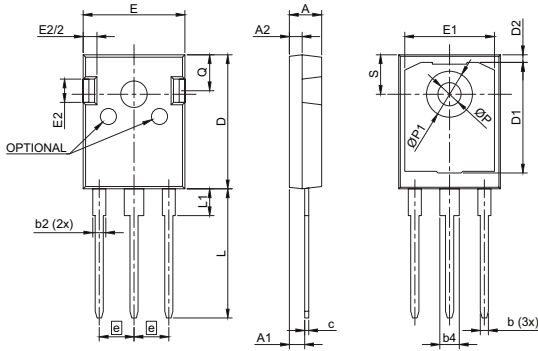

Figure 8: Transient Thermal Impedance



Package Dimensions TO-247-3L



Recommended Hole Pattern Layout

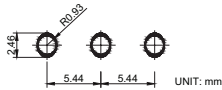

- Notes:
 1. Dimensions are in millimeters
 2. Dimension D, E do not include mold flash. Mold flash shall not exceed 0.127 mm per side. These measured at the outermost extreme of plastic body.
 3. ϕP to have a maximum draft angle of 1.5° to the top of the part with a maximum hole diameter of 0.154"

Symbol	Millimeters		
	Min	Nom	Max
A	4.80	5.03	5.20
A1	2.25	2.38	2.54
A2	1.85	1.98	2.11
b	0.99	-	1.40
b2	1.65	-	2.39
b4	2.59	-	3.43
c	0.38	0.64	0.89
D	20.80	20.96	21.34
D1	13.50	-	-
D2	0.51	1.19	1.35
e	5.44 BSC		
E	15.75	15.90	16.13
E1	13.06	14.02	14.15
E2	4.19	4.32	4.83
L	19.81	20.19	20.57
L1	3.81	4.19	4.45
ϕP	3.55	3.61	3.66
$\phi P1$	7.06	7.19	7.32
Q	5.49	5.61	6.20
S	6.05	6.17	6.30

Part Numbering and Marking System

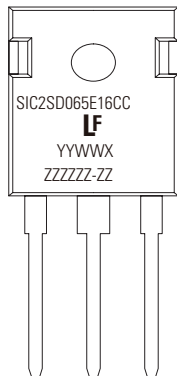

- SIC = SiC
 2 = Gen2
 SD = Schottky Diode
 065 = Voltage Rating (650 V)
 E = TO-247-3L
 16 = Current Rating (16 A)
 CC = Common Cathode
 YY = Year
 WW = Week
 X = Trace Code (Any Letter)
 ZZZZZZ-ZZ = Lot Number

Packing Options

Part Number	Marking	Packing Mode	M.O.Q
LSIC2SD065E16CCA	SIC2SD065E16CC	Tube (30pcs)	450

Packing Specification TO-247-3L

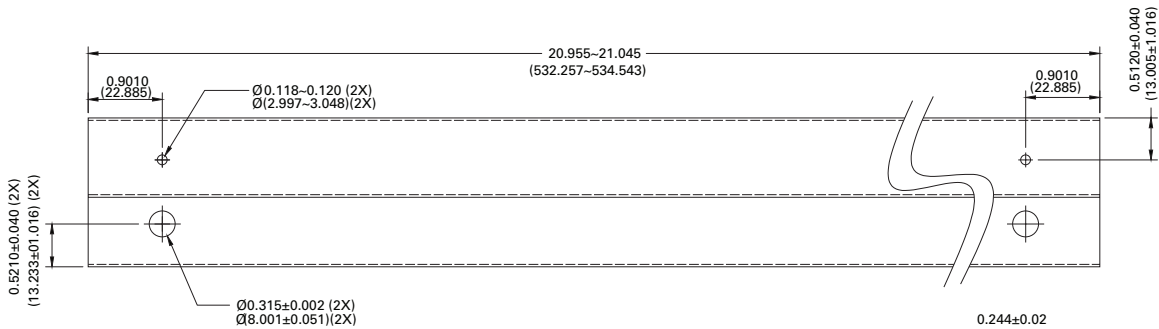

NOTE:

1. All pin plug holes are considered critical dimension
2. Tolerance is to be ± 0.010 unless otherwise specified
3. Dimension are in inches (and millimeters).

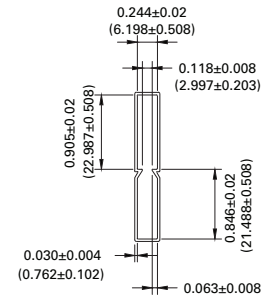

Disclaimer Notice - Littelfuse products are not designed for, and shall not be used for, any purpose (including, without limitation, automotive, military, aerospace, medical, life-saving, life-sustaining or nuclear facility applications, Components intended for surgical implant into the body, or any other application in which the failure or lack of desired operation of the product may result in personal injury, death, or property damage) other than those expressly set forth in applicable Littelfuse product documentation. Warranties granted by Littelfuse shall be deemed void for products used for any purpose not expressly set forth in applicable Littelfuse documentation. Littelfuse shall not be liable for any claims or damages arising out of products used in applications not expressly intended by Littelfuse as set forth in applicable Littelfuse documentation. The sale and use of Littelfuse products is subject to Littelfuse Terms and Conditions of Sale, unless otherwise agreed by Littelfuse. Information furnished is believed to be accurate and reliable. However, users should independently evaluate the suitability of and test each product selected for their own applications. Littelfuse products are not designed for, and may not be used in, all applications. Read complete Disclaimer Notice at www.littelfuse.com/disclaimer-electronics.